



FEATURES

- RoHS compliant
- Single output rail
- 1kVDC isolation
- High efficiency for low power applications
- SIP & DIP package styles
- Power density 0.36W/cm³
- UL 94V-0 package material
- Footprint from 0.69cm²
- 5V & 12V input
- 5V, 9V, 12V & 15V output
- No heatsink required
- Internal SMD construction
- Fully encapsulated with toroidal magnetics
- No external components required
- MTTF up to 2.2 million hours
- Custom solutions available
- Pin compatible with NKE, NME & NML series
- PCB mounting

DESCRIPTION

The LME series of DC/DC converters are optimised for low-power operation. They are ideally suited to generating a negative supply where only a positive rail exists.



For full details go to www.murata-ps.com/rohs

SELECTION GUIDE

Order Code	Nominal Input Voltage	Output Voltage	Output Current	Efficiency	Isolation Capacitance	MTTF ¹	Package Style
	V	V	mA	%	pF	kHrs	
LME0505DC	5	5	50	70	29	2279	DIP
LME0509DC	5	9	28	75	37	1139	
LME0512DC	5	12	21	75	41	624	
LME0515DC	5	15	16	75	40	357	
LME0505SC	5	5	50	70	29	2279	SIP
LME0509SC	5	9	28	75	37	1139	
LME0512SC	5	12	21	75	41	624	
LME0515SC	5	15	16	75	40	357	
LME1205DC	12	5	50	70	38	536	DIP
LME1209DC	12	9	28	75	40	434	
LME1212DC	12	12	21	75	43	330	
LME1215DC	12	15	16	75	45	237	
LME1205SC	12	5	50	70	38	536	SIP
LME1209SC	12	9	28	75	40	434	
LME1212SC	12	12	21	75	43	330	
LME1215SC	12	15	16	75	45	237	

When operated with additional external load capacitance the rise time of the input voltage will determine the maximum external capacitance value for guaranteed start up. The slower the rise time of the input voltage the greater the maximum value of the additional external capacitance for reliable start up.

INPUT CHARACTERISTICS

Parameter	Conditions	Min.	Typ.	Max.	Units
Voltage range	Continuous operation, 5V input types	4.5	5.0	5.5	V
	Continuous operation, 12V input types	10.8	12	13.2	

OUTPUT CHARACTERISTICS

Parameter	Conditions	Min.	Typ.	Max.	Units
Rated Power ²	T _A =0°C to 70°C			0.25	W
Voltage Set Point Accuracy	See tolerance envelope				
Line regulation	High V _{IN} to low V _{IN}		1.0	1.2	%/%
Load Regulation ²	10% load to rated load, 5V output types			15	%
	10% load to rated load, all other types			10	
Ripple and Noise	BW=DC to 20MHz, all output types			100	mV p-p

ISOLATION CHARACTERISTICS

Parameter	Conditions	Min.	Typ.	Max.	Units
Isolation test voltage	Flash tested for 1 second	1000			VDC
Resistance	Viso= 500VDC	1			GΩ

GENERAL CHARACTERISTICS

Parameter	Conditions	Min.	Typ.	Max.	Units
Switching frequency	All input types		100		kHz

ABSOLUTE MAXIMUM RATINGS

Short-circuit protection ³	1 second
Lead temperature 1.5mm from case for 10 seconds	300°C
Input voltage V _{IN} , LME05 types	7V
Input voltage V _{IN} , LME12 types	15V

1. Calculated using MIL-HDBK-217F with nominal input voltage at full load.

2. See derating curve.

3. Supply voltage must be disconnected at the end of the short circuit duration.

All specifications typical at T_A=25°C, nominal input voltage and rated output current unless otherwise specified.

TEMPERATURE CHARACTERISTICS					
Parameter	Conditions	Min.	Typ.	Max.	Units
Specification	All output types	0		70	°C
Storage		-55		130	
Cooling	Free air convection				

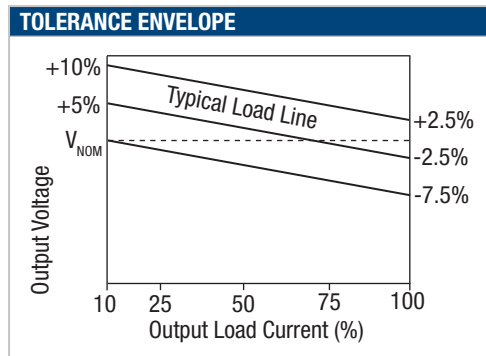
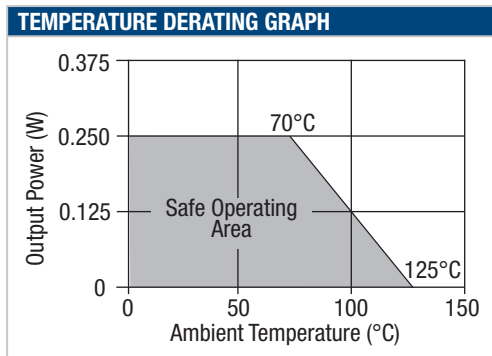

TECHNICAL NOTES

ISOLATION VOLTAGE

'Hi Pot Test', 'Flash Tested', 'Withstand Voltage', 'Proof Voltage', 'Dielectric Withstand Voltage' & 'Isolation Test Voltage' are all terms that relate to the same thing, a test voltage, applied for a specified time, across a component designed to provide electrical isolation, to verify the integrity of that isolation.

Murata Power Solutions LME series of DC/DC converters are all 100% production tested at their stated isolation voltage. This is 1kVDC for 1 second.

A question commonly asked is, "What is the continuous voltage that can be applied across the part in normal operation?"

For a part holding no specific agency approvals, such as the LME series, both input and output should normally be maintained within SELV limits i.e. less than 42.4V peak, or 60VDC. The isolation test voltage represents a measure of immunity to transient voltages and the part should never be used as an element of a safety isolation system. The part could be expected to function correctly with several hundred volts offset applied continuously across the isolation barrier; but then the circuitry on both sides of the barrier must be regarded as operating at an unsafe voltage and further isolation/insulation systems must form a barrier between these circuits and any user-accessible circuitry according to safety standard requirements.

REPEATED HIGH-VOLTAGE ISOLATION TESTING

It is well known that repeated high-voltage isolation testing of a barrier component can actually degrade isolation capability, to a lesser or greater degree depending on materials, construction and environment. The LME series has toroidal isolation transformers, with no additional insulation between primary and secondary windings of enameled wire. While parts can be expected to withstand several times the stated test voltage, the isolation capability does depend on the wire insulation. Any material, including this enamel (typically polyurethane) is susceptible to eventual chemical degradation when subject to very high applied voltages thus implying that the number of tests should be strictly limited. We therefore strongly advise against repeated high voltage isolation testing, but if it is absolutely required, that the voltage be reduced by 20% from specified test voltage.

This consideration equally applies to agency recognized parts rated for better than functional isolation where the wire enamel insulation is always supplemented by a further insulation system of physical spacing or barriers.

RoHS COMPLIANT INFORMATION



This series is compatible with RoHS soldering systems with a peak wave solder temperature of 300°C for 10 seconds. The pin termination finish on the SIP package type is Tin Plate, Hot Dipped over Matte Tin with Nickel Preplate. The DIP types are Matte Tin over Nickel Preplate. Both types in this series are backward compatible with Sn/Pb soldering systems.

For further information, please visit www.murata-ps.com/rohs

PACKAGE SPECIFICATIONS

MECHANICAL DIMENSIONS

DIP Package

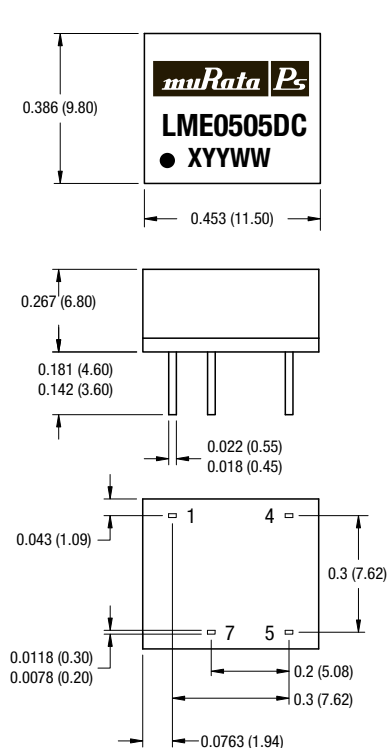

SIP Package

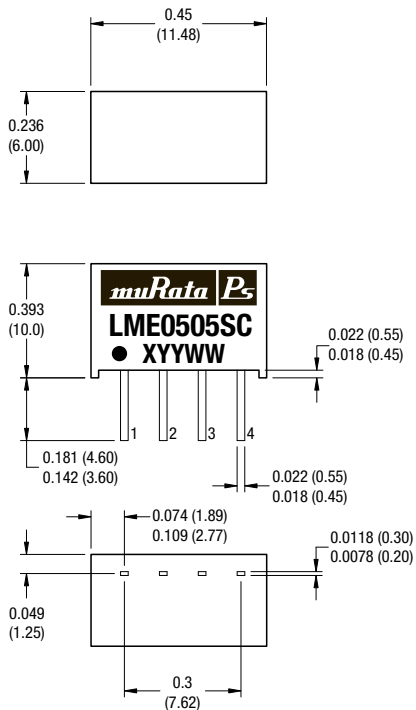

All dimensions in inches ± 0.01 (mm ± 0.25 mm). All pins on a 0.1 (2.54) pitch and within ± 0.01 (0.25) of true position.

Weight: 1.30g (SIP) 1.48g (DIP)

PIN CONNECTIONS - 8 PIN DIP

Pin	Function
1	-VIN
4	+VIN
5	+VOUT
7	-VOUT

PIN CONNECTIONS - 4 PIN SIP

Pin	Function
1	-VIN
2	+VIN
3	-VOUT
4	+VOUT

PACKAGE SPECIFICATIONS (continued)

RECOMMENDED FOOTPRINT DETAILS

8 Pin DIP Package

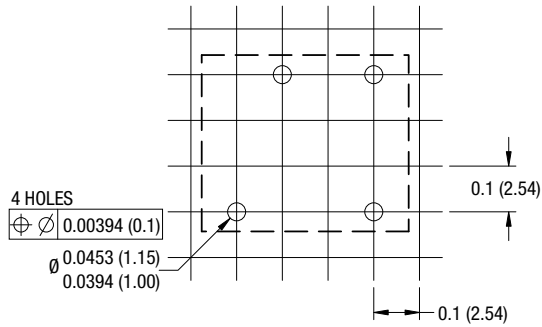

4 Pin SIP Package

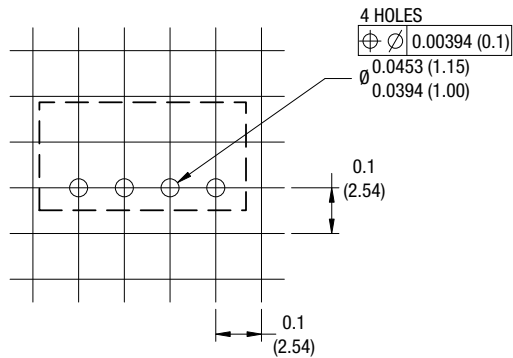

Unless otherwise stated all dimensions in inches (mm ± 0.5 mm).

TUBE OUTLINE DIMENSIONS

8 Pin DIP Tube

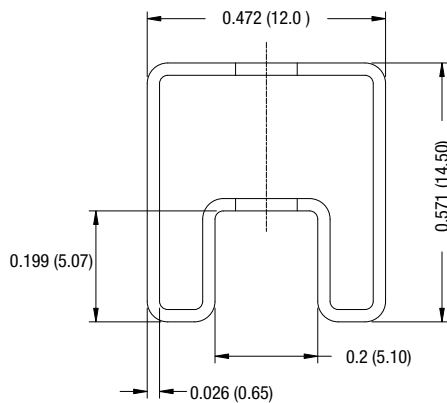

4 Pin SIP Tube

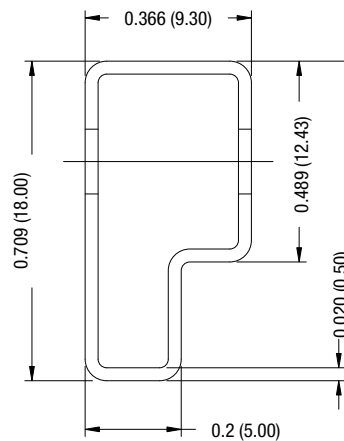

Unless otherwise stated all dimensions in inches (mm ± 0.5 mm).
 Tube length (8 Pin DIP) : 20.47 (520mm ± 2 mm).
 Tube length (4 Pin SIP) : 20.47 (520mm ± 2 mm).

Tube Quantity : 35